

bench components

components

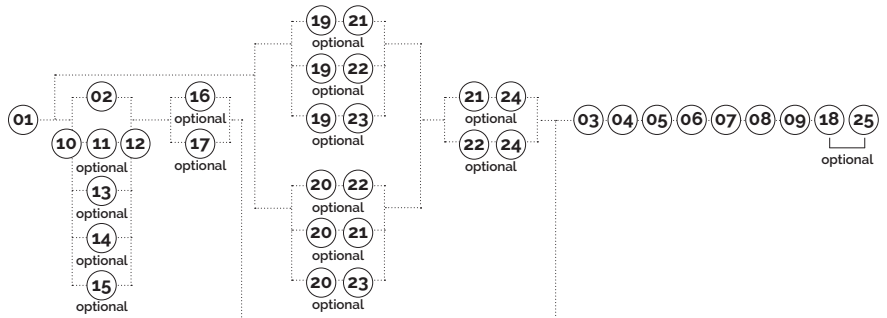

designed by:
r&d albacomponents

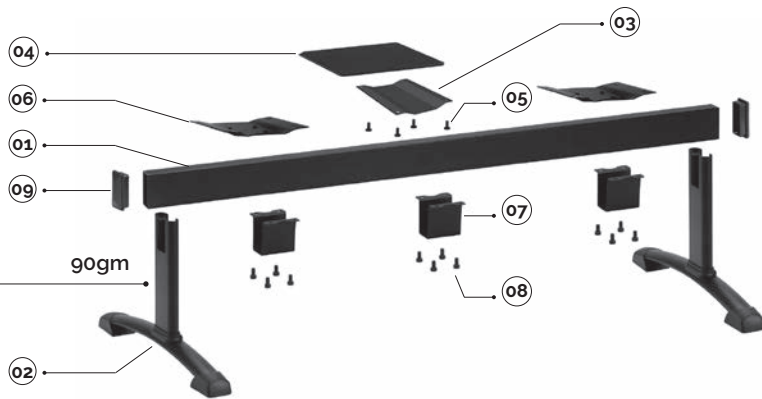

main component sizes

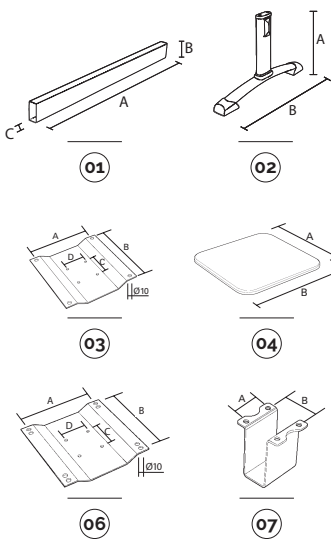

01 90t-trave per panca 90t-beam for bench

code	finishing		q.kit	q.pack	a	b	c	kg.x1	vol.x1
110703-020	● nero/black	2 posti/2 seats	x1	1	1000	80	40	2,80	mc. 0,003
110704-043	● grigio/grey	2 posti/2 seats	x1	1	1000	80	40	2,80	mc. 0,003
110703-021	● nero/black	3 posti/3 seats	x1	1	1500	80	40	4,20	mc. 0,0045
110704-044	● grigio/grey	3 posti/3 seats	x1	1	1500	80	40	4,20	mc. 0,0045
110703-022	● nero/black	4 posti/4 seats	x1	1	2000	80	40	5,60	mc. 0,006
110704-045	● grigio/grey	4 posti/4 seats	x1	1	2000	80	40	5,60	mc. 0,006
110703-023	● nero/black	5 posti/5 seats	x1	1	2500	80	40	7,00	mc. 0,0085
110704-046	● grigio/grey	5 posti/5 seats	x1	1	2500	80	40	7,00	mc. 0,0085

02 90gm-gamba mobile per panca con accessori 90gm-movable leg for bench with accessories

code	finishing		q.kit	q.pack	a	b	kg.x1	vol.x1
110703-005	● nero/black		x2	2	380	600	2,70	mc. 0,012
110704-001	● grigio/grey		x2	2	380	600	2,70	mc. 0,012
110710-001	● cromato/chrome		x2	2	380	600	2,70	mc. 0,012

03 90ap-attacco porta piano 90ap-table attachment

code	finishing		q.kit	q.pack	a	b	c	d	kg.x1	vol.x1
110703-014	● nero/black		x1	25	170	200	65	55	1,00	mc. 0,0002
110704-019	● grigio/grey		x1	25	170	200	65	55	1,00	mc. 0,0002

04 90tn-piano tavolo per panca 90tn-table for bench

code	finishing		q.kit	q.pack	a	b	kg.x1	vol.x1
120303-001	● nero/black		x1	10	400	400	2,20	mc. 0,002

05 vite tc + m6x12 brunita nera screw tc + m6x12 burnishing black

code	finishing		q.kit
117703-177	● nero/black		x4

06 92p-piastra per panca verniciata 92p-plate for bench paint

code	finishing		q.kit	q.pack	a	b	c	d	kg.x1	vol.x1
110703-013	● nero/black		x1	25	153	200	65	55	0,85	mc. 0,0008

07 90cv-cavalotto sotto trave 90cv-support under beam

code	finishing		q.kit	q.pack	a	b	kg.x1	vol.x1
110703-007	● nero/black		x1	50	55	65	0,60	mc. 0,0005
110704-015	● grigio/grey		x1	50	55	65	0,60	mc. 0,0005

08 confezione vite m8x12 testa cilindrica esagonale incassato brunita nera screw m8x12 cylindrical head hexagon embedded burnishing black package

code	finishing		q.kit	q.pack
117003-070	● nero/black		x4	200

09 tappo copritesta rettangolare 80x40 nero rectangular cover head cap 80x40 black

code	finishing		q.kit
134103-001	● nero/black		x2

bench leg & arm options

components

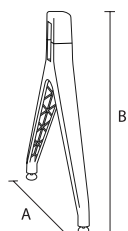

certification / Jim



EN16139

- 10 jim-gamba in plastica nera
jim-plastic bench leg_black

code	finishing	q.kit	q.pack	a	b	kg.x1	vol.x1
130703-004	● nero/black	x2	10	630	425	0,95	mc. 0,0102

- 11 jim-cavalotto x fissaggio gamba nero in plastica
jim-plastic bracket for bench leg - black

code	finishing	q.kit	q.pack	kg.x1	vol.x1
130703-005	● nero/black	x2	10	0,16	mc. 0,0005

- 12 jim-confezione accessori x 10 gambe
jim- accessories bag for 10 legs

code	finishing	q.kit	q.pack	kg.x1	vol.x1
130703-007	● nero/black	x0.2	1	0,15	mc. 0,0004

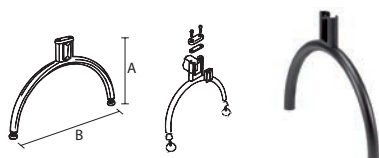

- 13 100gm-gamba mobile per panca con accessori
100gm-movable leg for bench with accessories

code	finishing	q.kit	q.pack	a	b	kg.x1	vol.x1
110703-008	● nero/black	x2	2	380	600	2,10	mc. 0,012
110704-006	● grigio/grey	x2	2	380	600	2,10	mc. 0,012
110710-005	● cromato/chrome	x2	2	380	600	2,10	mc. 0,012

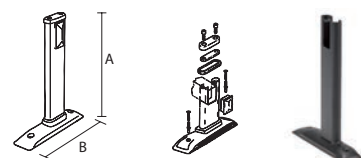

- 14 90gf-gamba fissa per panca con accessori
90gf-fixed leg for bench with accessories

code	finishing	q.kit	q.pack	a	b	kg.x1	vol.x1
110703-030	● nero/black	x2	2	380	310	1,90	mc. 0,012
110704-012	● grigio/grey	x2	2	380	310	1,90	mc. 0,012

designed by:
stefano bettio

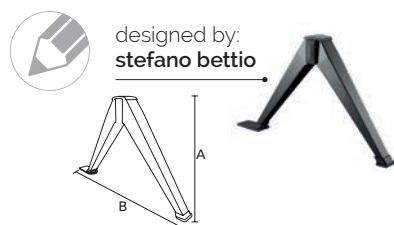

- 15 200gm-gamba mobile per panca con accessori
200gm-movable leg for bench with accessories

code	finishing	q.kit	q.pack	a	b	kg.x1	vol.x1
110703-110	● nero/black	x2	4	380	600	2,60	mc. 0,005
110704-110	● grigio/grey	x2	4	380	600	2,60	mc. 0,005
110710-110	● cromato/chrome	x2	4	380	600	2,60	mc. 0,005

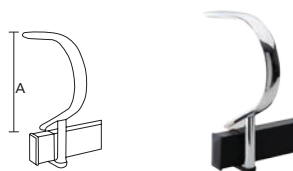

- 16 pioneer-bracciolo ellittico 40x20 per panca con accessori
pioneer-elliptical 40x20 arm for bench with accessories

code	finishing	q.kit	q.pack	a	kg.x1	vol.x1
111703-015	● nero/black	x1	5	260	1,10	mc. 0,005
111704-015	● grigio/grey	x1	5	260	1,10	mc. 0,005
111710-015	● cromato/chrome	x1	5	260	1,10	mc. 0,005

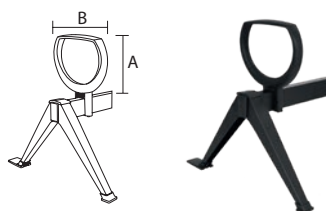

- 17 apoll-bracciolo in plastica + cavallotto per panca
apoll-plastic arm + support for bench

code	finishing	q.kit	q.pack	a	b	kg.x1	vol.x1
131703-065	● nero/black	x1	10	275	300	0,90	mc. 0,008



- 18 connettore trave panca
beam bench connector

code	finishing	q.kit	q.pack	a	b	kg.x1
110703-025	● nero/black	x1	10	75	36 400	1,42

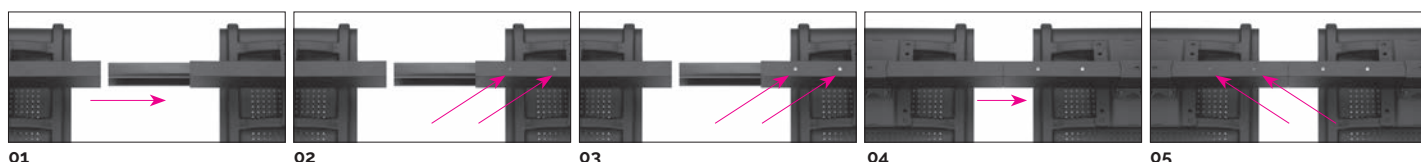

01

02

03

04

05

bench leg & arm options

components / cut & slim options



designed by:
alessandro crosera

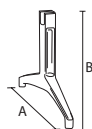

19 cut-gamba in alluminio per gamba panca + n°2 piedini
cut-aluminium leg for bench + n°2 glides

code	finishing	q.kit	q.pack	a	b	kg.x1	vol.x1
111704-224	⦿ alluminio/aluminium	x2	5	610	350	2,75	mc. 0.0132

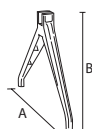

20 slim-gamba in alluminio per gamba panca + n°2 piedini
slim-aluminium leg for bench + n°2 glides

code	finishing	q.kit	q.pack	a	b	kg.x1	vol.x1
111704-226	⦿ alluminio/aluminium	x2	5	610	350	1,3125	mc. 0.0102

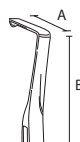

21 cut-bracciolo in alluminio per panca + n°2 viti
cut- aluminium arm for bench + n°2 screws

code	finishing	q.kit	q.pack	a	b	kg.x1	vol.x1
111704-223	⦿ alluminio/aluminium	x1	10	300	305	1,6065	mc. 0.0028



22 slim-bracciolo in alluminio per panca + n°2 viti
slim- aluminium arm for bench + n°2 screws

code	finishing	q.kit	q.pack	a	b	kg.x1	vol.x1
111704-225	⦿ alluminio/aluminium	x1	10	325	305	1,464	mc. 0.0049



23 cut/slim-cavalotto in alluminio per gamba panca + n°2 viti
cut/slim aluminium bracket 80x40 for bench leg + n°2 screws

code	finishing	q.kit	q.pack	a	b	kg.x1	vol.x1
111704-222	⦿ alluminio/aluminium	x2	10	60	95	0,30	mc. 0.0005

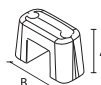

24 cut/slim-cavalotto in alluminio per bracciolo panca
cut/slim aluminium bracket 80x40 for bench arm

code	finishing	q.kit	q.pack	a	b	kg.x1	vol.x1
111704-221	⦿ alluminio/aluminium	x1	10	58	95	0,38	mc. 0.0005

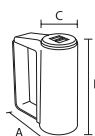

25 e:usb-caricatore per panca
e:usb-bench plug

code	finishing	q.kit	q.pack	a	b	c	kg.x1	vol.x1
130703-002	● nero/black	x1	5	85	100	38	0,28	mc. 0.0009

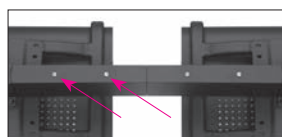

06



07

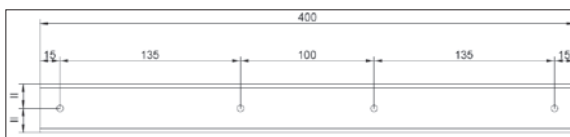

trama di foratura consigliata, lato inferiore trave
hole pattern suggested, underneath side of the beam